

CP600

CP series



TECHNICAL SPECIFICATIONS

Working weight	620 Kg
Excavator weight	5/11 ton
Cylinder force	34 t
Cylinders working pressure	300 bar
Cylinder oil flow	60/120 l/min
Rotation engine pressure	100 bar
Rotation oil flow (Min/Max)	10/12 l/min
Max jaws opening (A) PR	580 mm
Max jaws opening (A) SC	300 mm
Max jaws opening (A) FR	--
FR Kit (to be mounted on PR jaws)	540 mm
Total height (B)	1670 mm
Rotation 360°	hydraulic

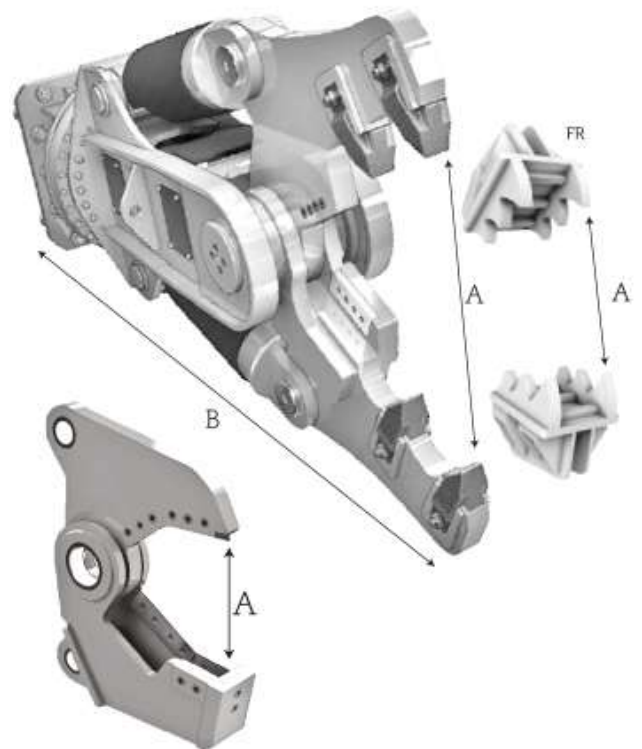

Cutting Data profile SC Jaws

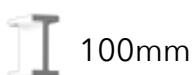

100mm



70mm



30mm